



**MVX**  
*Soft Starter*

**AuCom**  
THE SOFT START SPECIALISTS

**DANGER**  
**HIGH**



# MVX

## MVX

Smaller size: The overall form factor is 60% smaller than our previous product MVS. The MVX is among the smallest medium voltage soft starter in its class. Smaller size is a big advantage in lowering the costs in building and provides more flexibility where space is limited, for example marine applications.

## INCREASED SAFETY

To ensure that your staff and plant are safe from arc faults, MVX is the only choice. MVX meets or exceeds all the relevant standards:

- IEC62271-200 for switchgear and apparatus, and internal arc fault resistance
- IEC62271-304 for switchgear and apparatus
- IEC60664-1 for electrical insulation
- NZS4219 for seismic resistance

## EASIER TO SERVICE

AuCom has eliminated complex disassembly to replace or service a part, AuCom MVX panels are designed with easy rack in-rack out operation, and components are easily accessible via hinged doors or removable panels while still keeping unauthorised people out.

## MORE FLEXIBILITY

Don't feel constrained in the choice of apparatus in your switchgear, AuCom panels are compatible with all of the major apparatus suppliers.

## THE BENEFIT OF EXPERIENCE

At every stage of the process your AuCom team will work hard to create the ideal AuCom solution to meet the needs of your application and budget.





## SOFT STARTER PHASE CASSETTE FEATURES



SELF-CONTAINED IP00 STARTER - GREAT OPTION FOR OEMS

SMALL FOOTPRINT IP00 STARTER

GP06 AND AIR INSULATION

STANDARD 150 MM POLE CENTRES

ISOLATED CONTROL VIA FIBRE OPTIC CONNECTIONS

RACK-IN/RACK-OUT PHASE CASSETTES

### RACK-IN/RACK-OUT

AuCom MVX soft starters are fully self-contained and easily serviced/replaced. AuCom can include a service trolley that enables one person to remove and replace the starter. Phase cassettes are installed via a rolling base which is easily integrated for OEM solutions.

### STANDARD COMPATIBILITY

All panels are constructed around 150 mm pole centres for compatibility with standard apparatus options from major suppliers. Soft starters are also built to plug in/out easily.

### SMALL FOOTPRINT

The compact size of the starter allows for a smaller overall panel dimension to save space in your switch room. Robust construction allows for reliable use in even the most demanding industrial locations.

## KEYPAD

### REAL LANGUAGE

The MVX features simple, plain language feedback on the soft starter's operation and events – no trip code look-ups. The MVX has language options for operation in English and Chinese.

### EASY TO READ SCREEN

The MVX has a real-language display, offering extensive feedback and real-time status information in an easy-to-read format. Comprehensive metering information, details of starter status and last start performance allow easy monitoring of the starter's performance at all times. Multiple status screens let you display the data most relevant to your application, or you can configure your own program-mable screen to show the most relevant information for your application.

### EVENT LOGS

A 99 position event log records all information on the starter's operating history, in separate event and trip logs to assist in troubleshooting. An eight position trip log records trip states and operating conditions at the time of trip.

- Phase currents and voltages
- Mains frequency
- Starter state
- Time and date

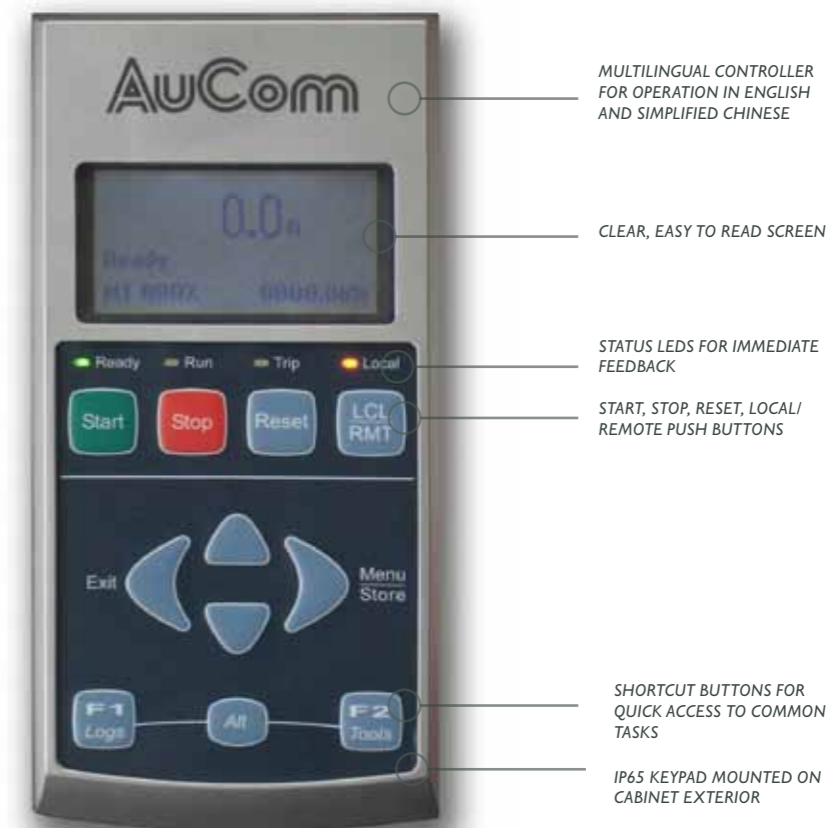

MULTILINGUAL CONTROLLER FOR OPERATION IN ENGLISH AND SIMPLIFIED CHINESE

CLEAR, EASY TO READ SCREEN

STATUS LEDS FOR IMMEDIATE FEEDBACK

START, STOP, RESET, LOCAL/REMOTE PUSH BUTTONS

SHORTCUT BUTTONS FOR QUICK ACCESS TO COMMON TASKS

IP65 KEYPAD MOUNTED ON CABINET EXTERIOR



ALL CONTROLS CENTRALLY LOCATED ON A SINGLE PANEL

EMERGENCY STOP BUTTON

### CENTRALISED CONTROL

All control of the soft starter is available from the single controller. The graphical display even allows real-time graphing of the starter operation. Isolated control is provided via fibre optic connections between the LV and MV sections.



## STARTING/STOPPING OPTIONS

### CONSTANT CURRENT

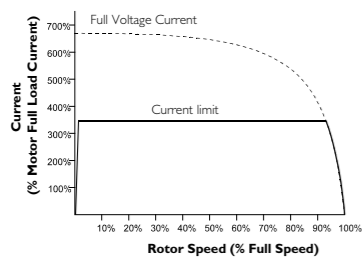

Suitable for most applications. Current is raised to specified level and held for duration of start.

### CURRENT RAMP

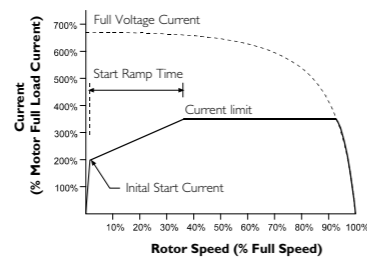

Better for generator sets or if conditions may vary between starts.

### KICKSTART

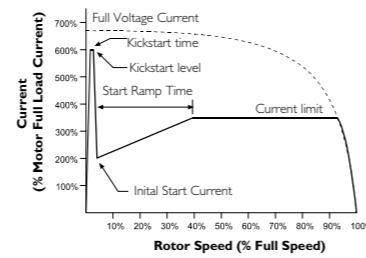

Provides a short boost of torque at the beginning of the start.

### COAST TO STOP

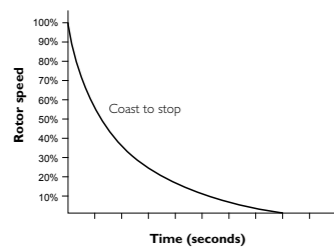

Removes voltage from motor and allows inertial slowing

### TIMED VOLTAGE RAMP

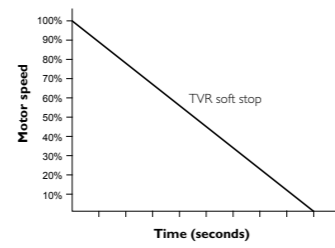

Gradually reduces voltage to extend deceleration time

### PUMP CONTROL STOP

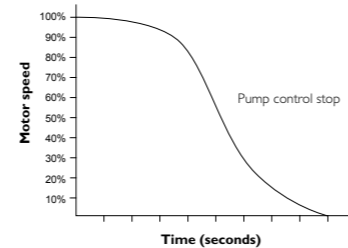

Provides gradual deceleration to reduce fluid hammer.

## PANEL CONSTRUCTION

### AVAILABILITY AND PARTITION

MVX panels are designed in compliance with availability classes LSC2B and partition class PM according to IEC 62271-200.

The switchgear compartments do not need any tools for opening. Interlocks allow access only when the corresponding high voltage parts are dead and earthed. Metallic shutters and partitions segregate the compartments from each other. When a compartment is opened all other panels in the installation and all cable termination compartments (including that in the panel concerned) remain in operation.

### ENCLOSURE

The enclosure is made of corrosion resistant hot dip galvanized steel sheets. Its design allows fast assembly with bolts only. No welding, balancing, grinding or cleansing is necessary, and no jigs are required for assembly.

Each panel is equipped with sidewalls. The special design provides an 8 mm air gap between two neighbouring panels. In the unlikely event of an internal arc, this design assures that the damage is limited to the panel where the fault occurred.

### DOORS

The coated doors are made from galvanized sheet steel. Robust hinges and handles provide for convenient and safe closing. The closing mechanisms are available for left or right hand operation.

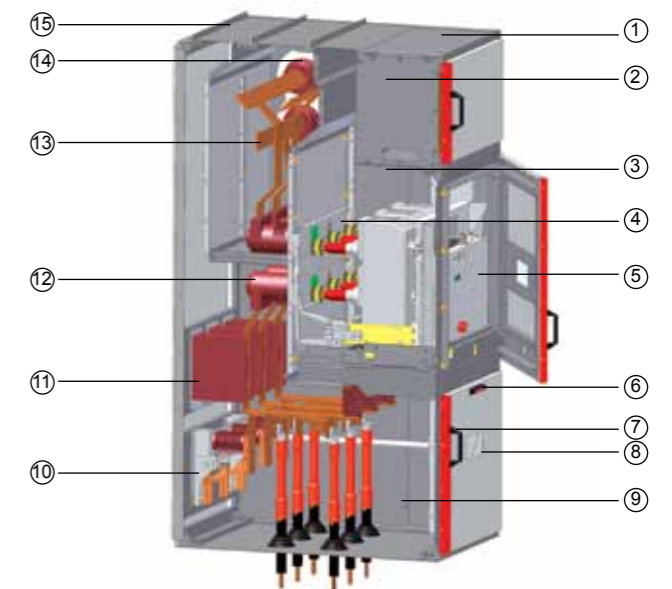

- 1 Enclosure
- 2 Low voltage compartment
- 3 Circuit breaker compartment
- 4 Shutter
- 5 Vacuum circuit breaker
- 6 Door lock
- 7 Door handle
- 8 Inspection window
- 9 Cable compartment
- 10 Earthing switch
- 11 Current transformer
- 12 Fixed contact insulator
- 13 Bus bar system
- 14 Bushing
- 15 Overpressure flap

## PANEL COMPARTMENTS

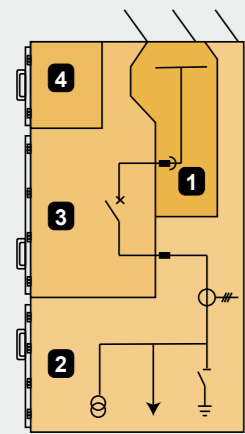

Front access panel layout

Each panel consists of three power compartments:

- bus bar compartment (1)
- cable compartment (2)
- circuit breaker compartment (3)
- the instrument compartment (4).

### 1. BUS BAR COMPARTMENT

The bus bar compartment houses the main bus bar system connected to the fixed upper isolating contacts of the circuit breaker by means of branch connections. The main bus bars are made of electrolytic copper. The bus bar compartment of each panel is segregated from the bus bar compartments of the neighbouring panels.

### 2. CABLE COMPARTMENT

The cable compartment houses the connection of the power cables to the bus bar. Additionally the earthing switch, surge arresters, voltage and current transformers can be installed. The compartment is closed with a metallic bottom plate.

### 3. CIRCUIT BREAKER COMPARTMENT

The circuit breaker compartment houses the bushing insulators containing fixed contacts for the connection of the circuit breaker with the bus bar and the cable compartment. The bushings are single-pole type and are made of cast resin, and covered by metallic shutters.

The metallic shutters operate automatically during movement of the circuit breaker from the racked-out position to the service position and vice versa.

The position of the circuit breaker can be seen from the front of the panel through a pressure-resistant inspection window.

## SAFETY

### ARC FAULT

An arc fault is a high power discharge of electricity between two or more conductors. They are an increasing concern among engineers when selecting MV switchboards. In the event of an arc fault the energy released in the fault rapidly vaporises metal, blasting molten metal and expanding plasma outward with extreme force. An electrical enclosure can be torn apart by the internal pressure against the weakest points of the enclosure, typically the hinges and joints between panels. More importantly a person nearby can be seriously injured or killed if an event such as an arc fault is not properly prepared for.

Arc fault releases destructive energy and can injure or kill nearby personnel, as well as damage your installation.

Arc faults can occur for a number of reasons, usually overvoltage, faulty insulation, mechanical failure or failure of a fuse. It will cause a sudden increase in energy expressed in a sudden rise in pressure, temperature as well as a sonic event such as a loud bang. The stress on enclosure panels doors and viewing windows may lead to their destruction, in some cases the shock wave will break parts and cause them to fly out from the explosion. The increase in temperature can cause melting and vaporisation of metals, ceramics and plastics, which in turn become combustible hot gases.

The arc event causes a sudden increase in pressure, followed by an expansion, emission phase and finally a thermal phase. In an MVX panel, the arc fault is

firstly contained in the expansion phase by solid locking doors and heavy double layer panels making up the compartments of the MCC. During the emission phase the pressure is released away from personnel standing in front of the panel (normally operating position), by preventing the flame or charge from dissipating forwards, instead pressure discharge flaps on the top of the panel (or optional ducts) direct the explosion upwards or vent it safely outside. These pressure discharge flaps will react in milliseconds to allow the heated gases to vent.

Arc fault events normally occur in less than a second, so not even the fastest person is able to react to protect themselves. The event will typically reach temperatures of around 10000° C, hot enough to liquefy most metals.

Responsible specifiers should ensure that they require all switchgear to meet IEC 62271-200. MVX panels are suited for Internal Arc Classification (IAC) AFLR to a maximum of 31.5 kA for 1 s.



Internal arc fault test, 31.5kA/1s

### TESTS

AuCom MVX panels have passed arc fault tests for the entire range of panel enclosures. (Type test certificates are available on request). MVX panels will even pass arc fault tests with the low voltage doors open.

All MVX panels pass the 5 acceptance criteria for an arc fault event under IEC62271-200:

- Doors and covers do not open. No debris part comes past the interior walls.
- The outer enclosure does not fragment and project within the test time.
- Arcing does not cause holes in the outer enclosure
- Indicators are not ignited.
- The enclosure remains connected to earth

The construction of the MVX panels uses arc fault resistant baffles to control and direct explosions away from the operator and safely direct via exhaust cut-outs in rear door or top of panel.



## TESTING AND SIMULATION

### SOFTWARE SIMULATIONS

The simulations function allow the MVX to be tested without a motor connected, to confirm that the soft starter's control circuits are operating correctly. There are three simulation modes available:

- Run simulation: simulates a motor starting, running and stopping to confirm correct configuration of main and bypass contactors, fibre-optic controls, programmable relays and motor control signals.
- Protection simulation: simulates activation of each protection mechanism to confirm that the soft starter is responding correctly in each situation.
- Signalling simulation: simulates output signalling to confirm configuration.

### LOW VOLTAGE TESTING

The MVX can be connected to a low voltage motor ( $\leq 500$  VAC) for testing. This allows the user to thoroughly test the soft starter and its associated power and control circuits. The low voltage test mode provides a means of testing the soft starter's configuration without requiring a full medium voltage test facility.

### SAFETY

- Fully type tested including internal arc tests according to IEC 62271-200 (IAC classified: AFLR, 31.5kA/1s).
- Mechanical interlocks and padlocks.
- All switching operations can be performed with the doors closed.
- Metallic shutters automatically protect high voltage components when the circuit breaker is withdrawn.

### TYPE TESTING

MVX panels are fully type tested according to IEC 62271-200:

- Short time and peak withstand current
- Temperature rise and main circuit impedance
- Dielectric test on main and auxiliary circuits
- Making and breaking capacity of the circuit breaker within the panel
- Earthing switch making capacity
- Mechanical operations
- Internal arc fault (IAC classified: AFLR, 31.5A/1s)



Type test reports

## PROTECTION

### PROTECTION

A wide range of protection features ensure your equipment can operate safely in the most demanding environments. Each protection can be individually adjusted to the required sensitivity, or can be disabled if required to ensure vital equipment continues to operate even in the most challenging situations.

### TRIPS

Trips and warnings are written to an eight-place trip log, together with information on motor and system status at the time, speeding up analysis of problems.

### DESIGN

- Depending on the design all compartments are accessible from the front. Alternatively the cable compartment is accessible from the rear.
- Cable connection points are all at comfortable height.
- Cable and circuit breaker compartments include pressure resistant inspection windows as standard.
- Fully flexible cabling and bus bar entry option
- Created for simple, straightforward manufacturing: No welding, balancing, grinding or cleansing procedures are required.
- Segregated bus bars from panel to panel.
- Optional arc venting shields or gas exhaust duct available.

### THERMAL CAPACITY

The thermal model will only permit a start which is predicted to succeed. This protects the motor against overloads which shorten the motor life.

### ADVANCED THERMAL MODELLING

Intelligent thermal modelling allows the soft starter to dynamically calculate motor temperature to predict whether the motor can successfully complete a start. The MVX uses information from previous and upcoming starts to calculate the motor temperature to predict the motor's available thermal capacity.

### PASSWORD PROTECTION

A multi-level password system provides security for parameter adjustments while still allowing users full access to the many metering functions.

### FIBRE OPTICS

Electrical isolation of low and high voltage circuits is assured by a two line fibre-optic interface between the power assembly and the control module. This fibre-optic link simplifies installation of chassis mount MVX units into custom switchboards.

### PROTECTION CODES

Protection description	MVS Protection (built-in)	
48	Maximum start time	Excess start time
66	Too many starts	Restart delay and dynamic thermal model
37	Undercurrent	
51L	Load Increase (alarm)	High current frequency output
51R	Overcurrent - jam	Excess start time, electronic shearpin
50	Overcurrent - short	Shorted SCR, electronic shearpin
49/51	Thermal overload	Thermal overload - dynamic model
46	Current imbalance	Current imbalance
	Positive/negative phase sequence	Phase sequence
27	Undervoltage	Undervoltage
59	Overvoltage	Overvoltage
47	Phase loss	Phase loss
47	Phase sequence	Phase sequence
50G	Ground fault	Ground fault
3	Communications failure	Communications failure
3	Internal failure	Internal failure
86/97	Ext. fault I/code - 1	Auxiliary trip A
	Ext. fault I/code - 2	Auxiliary trip B
38	Motor overtemperature	Thermistor protection*
49	Stator winding overtemperature	Thermistor protection*
32	Under power	Power Loss

\* RTD Relay is an optional extra.



## SAFETY FEATURES

## RATINGS

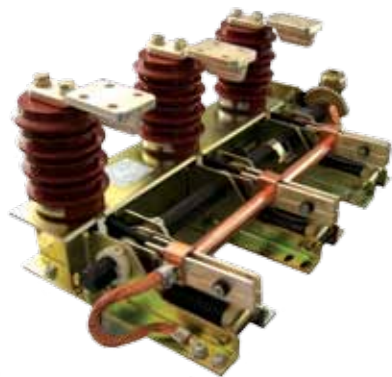

Make-proof earthing switch

### ISOLATION

MVX panels use a combination of air and GP03 insulation and features to ensure personnel safety when working in the MV environment. Unlike messy oil or water insulation, GP03 is able to provide a smaller overall dimension without the hassle or reliability issues.

Fibre-optic insulation between the low voltage controller and the high voltage power assembly provides complete electrical isolation.

### COMPARTMENT DESIGN

Compartment design isolates LV and MV equipment allowing operators to service LV equipment without de-energising MV sections. Bus bars are allocated a separate compartment at the rear of the panel that allows access across multiple panels when mounted as an MCC.



Interlock for circuit breaker compartment door

### DOOR LOCKS

Every compartment door has built-in locking as standard. Tags may also be applied to indicate sections with work in progress.

### INTERLOCKS

Protection to personnel is ensured the interlocking of apparatus equipment being racked in or out to the point of locking. Interlocking also prevents unauthorised personnel from opening rear door to MV compartments.



Properly designed labyrinths as well as additional steel sheets provide maximum operator safety in case of internal arc fault



Swinghandle locks on the doors provide additional safety



Rounded edges guarantee safe handling

AuCom selects each MVX to suit your needs. Choose a starter to suit your site conditions such as altitude, ambient temperature, load, and starts per hour.

AuCom MVX ratings are detailed using the AC53b utilisation code. An example is shown below.

**I65 A:AC-53b 5-30 : I770**

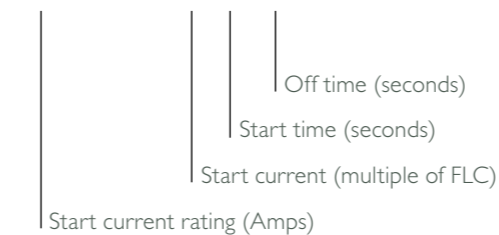

### STARTER CURRENT RATING

The full load current rating of the soft starter given the parameters detailed in the remaining sections of the utilisation code.

### START CURRENT

The maximum available start current as a multiple of FLC.

### START TIME

The maximum available start current.

### OFF TIME

The minimum allowable time between the end of one start and the beginning of the next start.



## SPECIFICATIONS

### General

Current Range ..... up to 1600 A (nominal)  
 Motor connection ..... In-line

### Supply

Mains Voltage (L1, L2, L3) ..... up to 3 x 15000 VAC  
 Control Voltage (A1, A2, A3) ..... 110 VAC to 130 VAC (+10% /-15%)  
 ..... or 220 VAC to 240 VAC (+10% /-15%)  
 Mains Frequency ..... 45 Hz to 66 Hz

### Inputs

Inputs ..... Active 24 VDC, 8 mA approx.  
 Start (C23, C24) ..... 24 VDC, 8mA approx.  
 Stop (C31, C32) ..... 24 VDC, 8mA approx.  
 Reset (C41, C42) ..... 24 VDC, 8mA approx.  
 Input A (C53, C54) ..... 24 VDC, 8mA approx.  
 Input B (C63, C64) ..... 24 VDC, 8mA approx.  
 Motor Thermistor (B4, B5)

### Outputs

Relay outputs ..... 10 A at 250 VAC/360 VA  
 ..... 10 A at 30 VAC resistive  
 Main Contactor (Terminals 13, 14) ..... Normally Open  
 Bypass Contactor (Terminals 23, 24) ..... Normally Open  
 Run Output/ PFC (Terminals 33, 34) ..... Normally Open  
 Output Relay A (Terminals 43, 44) ..... Normally Open  
 Output Relay B (Terminals 51, 52, 54) ..... Changeover  
 Output Relay C (Terminals 61, 62, 64) ..... Changeover  
 Analog Output (Terminals B10, B11) ..... 0-20 mA or 4-20 mA

### Environmental

Protection  
 Power Assembly ..... IP00  
 Contoller ..... IP54/ NEMA 12  
 Operating Environment (IEC60721-3-3) ..... -5 °C to 55 °C  
 (heat pumps may extend this range)  
 Storage Temperature ..... - 25 °C to + 55 °C  
 Relative Humidity (IEC60721-3-1: IEI2) ..... -5 °C to 45 °C  
 Conformal coating of PCBs ..... Standard

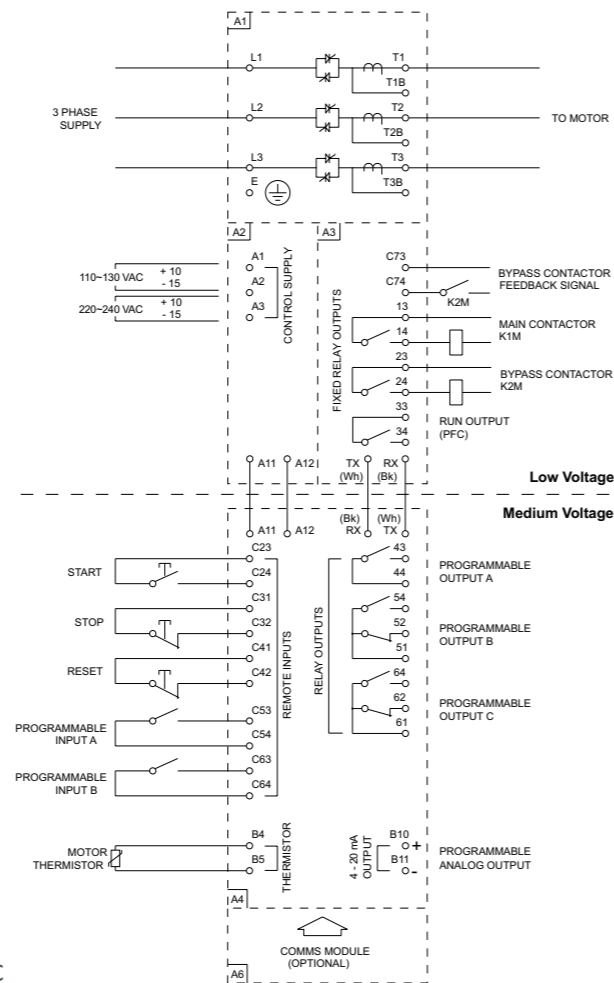

ITEM	DESCRIPTION
A1	POWER ASSEMBLY
A2	CONTROL VOLTAGE TERMINAL BLOCK
A3	POWER INTERFACE PCB
A4	CONTROLLER
A6	COMMS MODULE (OPTIONAL)
K1M	MAIN CONTACTOR
K2M	BYPASS CONTACTOR



## DIMENSIONS

### PHASE CASSETTES

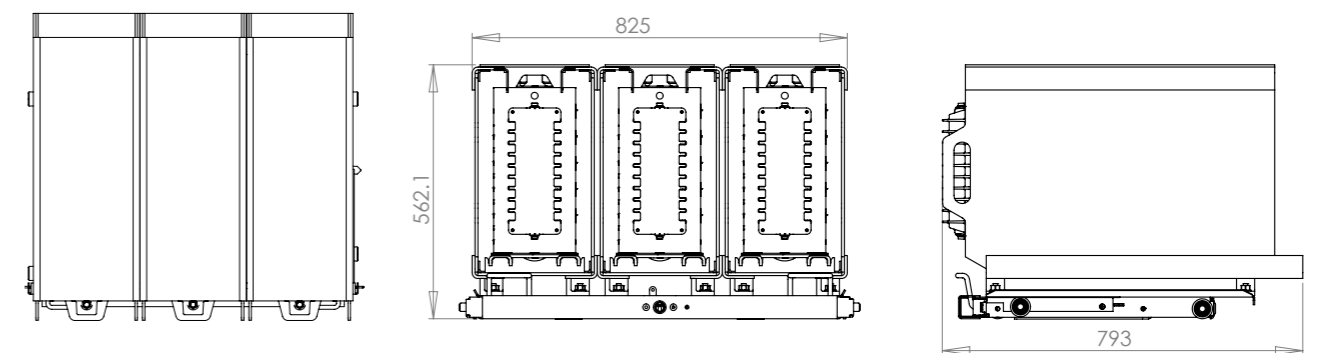

### PANELS

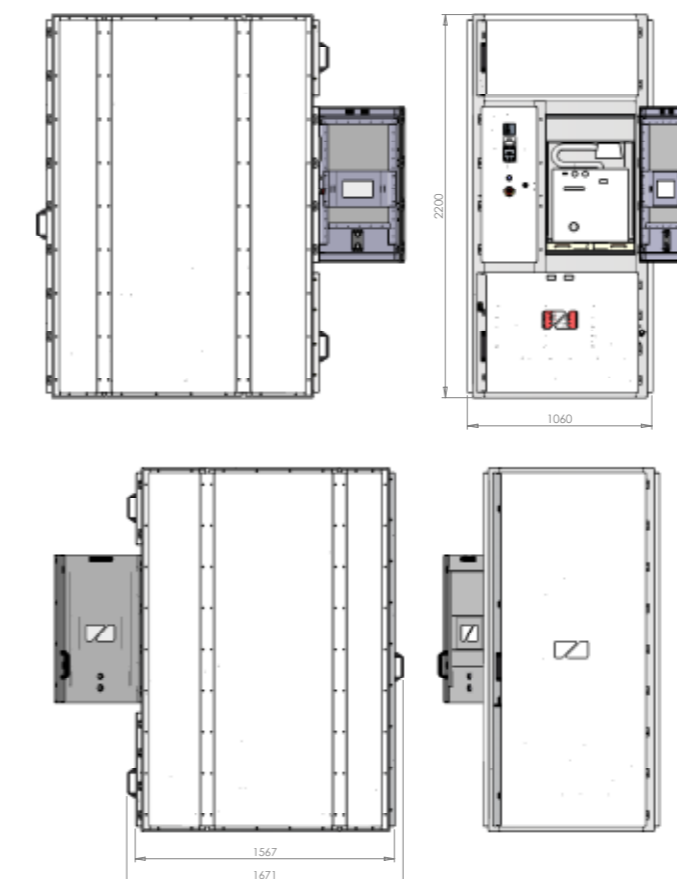





## EQUIPMENT OPTIONS

AuCom is a one-stop shop with full design capabilities. We offer a wide range of options for your application such as:

### MV SWITCHING AND PROTECTION

- Earth Switch
- Vacuum Circuit Breakers
- Fuse contactor
- MOVs

Apparatus is easily installed by one person using the AuCom Service trolley. Equipment is rolled onto the service trolley and rolls into the panel via small track connectors.

### POWER FACTOR CORRECTION OPTIONS

- Capacitors
- Inductors
- Fuses
- Contactors

### AUXILIARY MODULES

- Measurement and protection current transformers
- Power meters
- Protection relays
- RTDs
- Inductive voltage transformers
- Panel heat pump
- Surge protection
- Protection relays

### COMMUNICATION

The MVX integrates into your existing monitoring and control network, using easy-to-install plug-in communication interfaces. The MVS supports Profibus, DeviceNet and Modbus RTU protocols. Communication modules are an optional extra.

- Modbus RTU Interface
- Profibus Interface
- DeviceNet Interface



### EARTHING SWITCH

Each feeder compartment can be equipped with an earthing switch for cable earthing.

When installed in measurement, bus-tie or bus riser panels it can also be used to earth the bus bar system.

The earthing switch has short circuit making capacity. The position of the earthing switch can be seen by means of mechanical position indication and in addition through an inspection window.

### INTERLOCKS

The switchgear is fitted with all interlocks needed to guarantee the highest level of safety for operators. The interlocking devices comply with IEC 62271-200 to prevent:

- closing of the circuit breaker in an intermediate position
- racking-out of the circuit breaker in closed position
- racking-in of the circuit breaker in closed position
- opening of the circuit breaker compartment door as long as the circuit breaker is not in test position. In addition if the panel is equipped with an earthing switch the interlocking devices prevent:
- racking-in of the circuit breaker with the earthing switch closed
- closing of the earthing switch when the circuit breaker is in connected or intermediate position
- opening of the cable compartment door with the earthing switch open

### LOCKS

Each door can be locked in its closed position.

Multiple insertion slots allow padlocks to be placed to prevent racking-in/out of the circuit breaker and opening/closing of the earthing switch.

The metallic shutters can be locked by means of two independent padlocks in both the open and closed positions.

## EQUIPMENT OPTIONS



Indoor support type current transformer and voltage transformer



Low duty circuit breaker



High duty circuit breaker



Connected power cable to the feeder busbar



Surge Arresters

### INSTRUMENT TRANSFORMERS

The panel is designed to be equipped with current transformers for measurement and protective purposes, toroidal current transformers and voltage transformers according to the dimensions of DIN 42600. For other transformers the panel can be adapted on request.

### POWER CABLES

Up to a maximum of 6 cables per phase can be used depending on the unit dimensions and the cable cross-section. Access to the cables is provided either from the front or from the rear. The cables enter the panel from the bottom. Optional top entry design is available.

### SURGE ARRESTERS

In the cable compartment space is provided for three fix mounted surge arresters to protect the equipment from switching overvoltages.

### VACUUM CIRCUIT BREAKER

MVX switchgear solutions are equipped as standard with an advanced vacuum circuit breaker which uses three single-coil magnetic actuators, one per pole. All switching elements are assembled along a single axis. All mechanical movements are therefore direct and linear. The three actuators are mounted in a steel frame and are mechanically linked by a synchronizing shaft.

This circuit breaker completely avoids failure of critical components such as

- mechanical latching
- gears, chains, bearings and levers
- tripping and closing coils
- motors to charge springs

The result is up to 150,000 C-O cycles at rated current or up to 100 operations at full short circuit breaking current without the need to replace or adjust any parts. The vacuum circuit breaker is maintenance free over the total life expectancy of at least 25 years.

Customer-specified circuit breakers can be integrated on request.

# OTHER AUCom PRODUCTS

AuCom offers a complete range of soft starters, with a solution for your soft starting requirement. Whether you need a simple product for starting only, or a comprehensive solution for your motor control and protection needs, you can trust AuCom to offer a product to match.

	Soft Start	Motor Protection	Advanced Interface	Internal Bypass	Power Range	Voltage Range
CSX	•			•	≤ 200 A	≤ 575 VAC
CSXi	•	•		•	≤ 200 A	≤ 575 VAC
IMS2	•	•	•		≤ 2361 A	≤ 690 VAC
EMX3	•	•	•	•	≤ 2400 A	≤ 690 VAC
MVX	•	•	•	•	≤ 390 A *	≤ 13.8 kV

\* Ratings higher than 390 A available on request.

## CSX SOFT START CONTROLLER



An advanced soft start controller designed for use in motor control centres. Easily incorporated into any control circuit and suitable for use with any type of motor protection device.

## CSXi COMPACT SOFT STARTER



A compact soft starter providing constant current soft start control and essential motor protection. A complete motor control solution in a single compact design.

## EMX3 ADVANCED SOFT STARTER



A complete motor management system providing constant current, and current ramp as well as the new XLR-8, Adaptive Acceleration Control, available only from AuCom.

## MVX MEDIUM VOLTAGE SOFT STARTER



An advanced motor management system for medium voltage motors. MVX soft starters provide a full range of soft start control, motor/load protection and other features.

For more information on AuCom products, contact your local distributor:

**AuCom**  
THE SOFT START SPECIALISTS

**AuCom Electronics Ltd.**

123 Wrights Road  
PO Box 80208  
Christchurch 8440  
New Zealand

**T** +64 3 338 8280

**F** +64 3 338 8104

**E** [salesupport@aucom.com](mailto:salesupport@aucom.com)

**W** [www.aucom.com](http://www.aucom.com)

© 2010 AuCom Electronics. As AuCom is continuously improving its products it reserves the right to modify or change the specification of its products at any time without notice. The text, diagrams, images and any other literary or artistic works appearing in this brochure are protected by copyright. Users may copy some of the material for their personal reference but may not copy or use material for any other purpose without the prior consent of AuCom Electronics Ltd. AuCom endeavours to ensure that the information contained in this brochure including images is correct but does not accept any liability for error, omission or differences with the finished product.